

Product introduction

PPA109S is an Emergency Lighting Control Device which is in compliance to UL924. PPA109S needs to work together with Wave smart lighting controllers and supporting products.

Various applications and suggested configurations of PPA109S are listed in this instruction. Readers shall get familiar with Wave APP and products by reading Wave smart lighting APP instruction and the specification and installation guidance documents of these products beforehand.

PPA109S can work with AC/DC 120-277V emergency power supply.

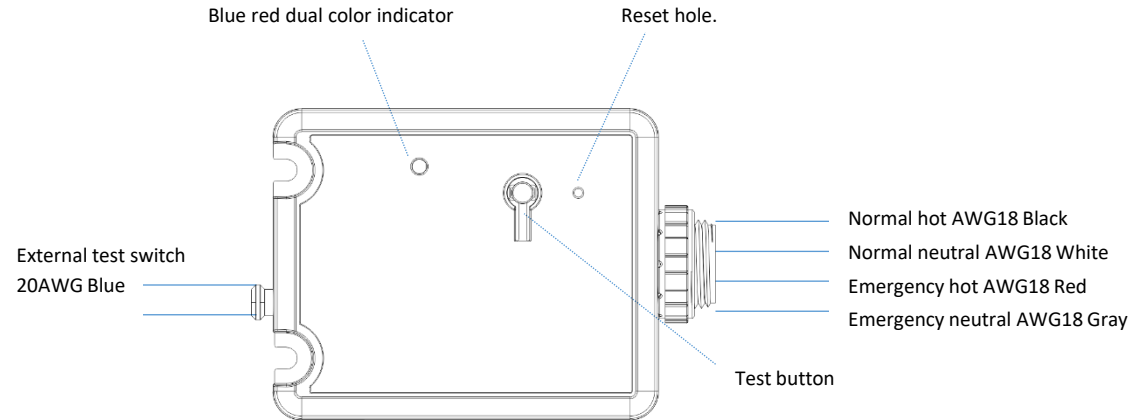

Blue red dual color indicator:

- Blue on: powered on
- Red on: emergency mode
- Red blink: emergency power is disrupted

Installation and commission

Installation and commission

Please install the PPA109S properly and place it to an appropriate place according to the specification and installation guidance documents. Do not place it in places where wireless signal transmission might be blocked, such as places close to metal plate or concrete wall, or places that are very far away from other Wave smart lighting controllers.

One PPA109S is usually sufficient for one ZONE. Please place the PPA109S in a position where its wireless signal can reach all emergency lights and devices. You may also install two or more PPA109S in one ZONE if wireless coverage is a concern.

Add PPA109S to mesh network:

Please add PPA109S to mesh network with APP after installing it properly and powering it on. PPA109S is to be added to a mesh network as a device. Please refer to APP instruction for details.

Parameter configuration

You may check the PPA109S in device page of the APP after adding it to network. Long press the icon can bring out the parameter configuration page.

Device name, click to update it.

10:25

< Back

ID024

Upon failure of normal power:

Action: Scene Group

Set group: All Lights

To level: 89, 90, 91, 92, 93

Repeat every (seconds): 3, 4, 5, 6, 7

Upon restore of normal power:

Action: None Scene Group

Set group: All Lights

Save

Select an action when normal power is disrupted.

Set the group and appropriate light level

Click to select a scene.

Set the repeat time

10:30

< Back

ID024

Upon failure of normal power:

Action: Scene Group

Scene: Full Light

Repeat every (seconds): 3, 4, 5, 6, 7

Upon restore of normal power:

Action: None Scene Group

Scene: Full Light

Save

Action when normal power is restored, none for default. You may choose scene or group. No need to repeat the command.

Click Save to save the settings

Parameters

Parameters when normal power is disrupted:

It will enter emergency lighting mode when normal power is disrupted. Parameters include:

- Action: The action for emergency lighting mode. It could be a pre-defined lighting scene, or a lights group.
- Group and light level: You may choose a lights group and appropriate light level for emergency lighting when you selected group for action. Group and light level shall be decided according to the actual lights and facility to meet the UL924 requirements for emergency lighting.
- Scene: You may select a scene when you selected scene for action. Scene shall be decided according to the actual lights and facility to meet the UL924 requirements for emergency lighting.
- Repeat interval: Wave smart lighting products use wireless communication technologies. To prevent user from mistakenly turning off or dimming the luminaires with APP or switches in case of emergency lighting conditions, PPA109S will send emergency lighting commands repeatedly.

Parameters when normal power is restored:

Luminaires need to be returned to normal lighting status when normal power is restored. Usually, Wave smart lighting products have sensors. Luminaires will automatically resume to normal lighting status as PPA109S stops sending emergency lighting commands when normal power is restored. So no need to send command explicitly

It might be necessary that PPA109S should send command to restore lights to normal lighting status according to the actual lights and facility. You need to configure it in the APP in this case. Parameters include:

- Action: The action for emergency lighting mode. It could be a pre-defined lighting scene, or a lights group.
- Group and light level: You may choose a lights group and appropriate light level for normal lighting when you selected group for action. Group and light level shall be decided according to the actual lights and facility to meet the requirements for lighting.
- Scene: You may select a scene when you selected scene for action. Scene shall be decided according to the actual lights and facility to meet the requirements for lighting.

Default parameter configuration:

Default factory parameter configuration: Turn “All lights” group to 100% level and repeat every 5 seconds when normal power interrupts. No action when normal power resumes.

Emergency function test

There is an emergency function test button on PPA109S. It simulates the emergency lighting function when normal power is disrupted when the button is pressed down so user may test it.



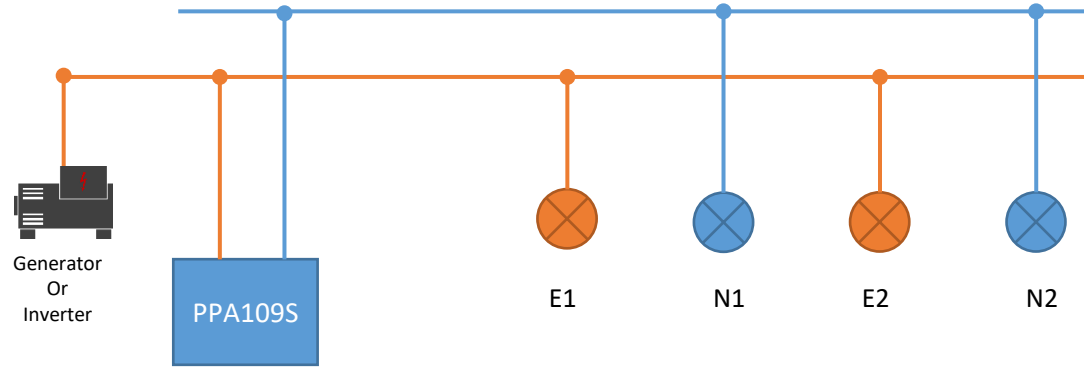

The test button is on the housing of the PPA109S. Press the button to simulate the emergency lighting function when normal power is disrupted. Release the button to go back to normal lighting status.

There is also a pair of connector for connecting a push button. You may connect a push button to the connector so to test it remotely by press the push button. Note: please do not connect the test button connector to any load or input voltage to avoid accidents.

Typical applications



Legend:

-  Normal power supply
-  Emergency power supply
-  Normal luminaires, provide lighting under normal status
-  Emergency luminaires, installed at critical positions to provide lighting only under emergency status
-  A generator or inverter to provide centralized emergency power supply

Typical application

Emergency and normal power supply are separate. All luminaires are controlled by Wave smart lighting controllers. Emergency luminaires are installed at critical positions and powered by emergency power supply. They only provide lighting under emergency conditions. Other luminaires are powered by normal power supply and only provide lighting under normal conditions.

Suggested configuration:

Create a group as “Emergency lights” and add E1/E2 as the group members.

When normal power is disrupted:

Set the action to “group” and set the “Emergency lights” group to “50” light level. (Suppose 50 light level is sufficient to meet emergency lighting requirement, otherwise please set the scene to desired level) Repeat every 5 seconds.



When normal power is restored:

Set the action to “group” and set the “Emergency lights” group to “0” light level.

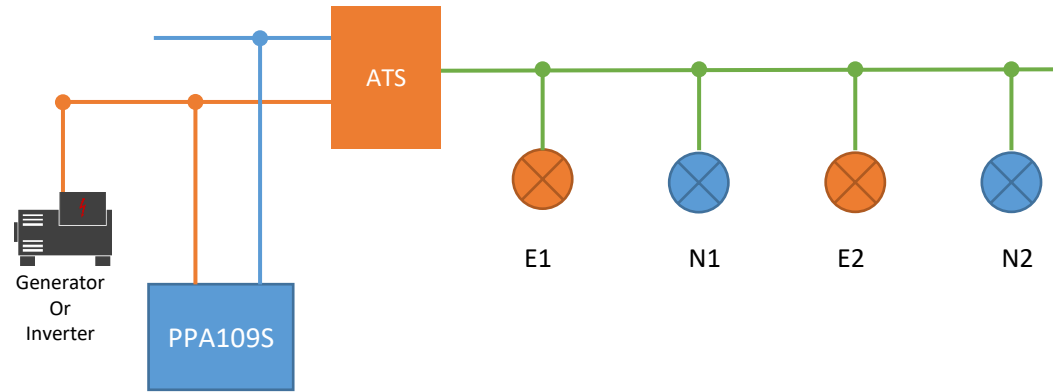
Typical applications





Legend:

-  Normal power supply
-  Emergency power supply
-  Luminaire power supply

 **ATS** Automatic Transfer Switch. It can automatically switch between normal and emergency power supply. To provide continuous power for loads.

 Normal luminaires, provide lighting under normal conditions.

 Emergency luminaires. Install at critical positions to provide lighting only under emergency conditions.

 A generator or inverter to provide centralized emergency power supply

Typical application

There is an ATS which provide power to all luminaires and can automatically switch to emergency power when normal power is disrupted. All luminaires are controlled by Wave smart lighting controllers. Luminaires installed at critical positions are emergency luminaires and they provide lighting under both normal and emergency conditions. Other luminaires are powered by normal power supply and only provide lighting under normal conditions.

Suggested configuration:

Create a scene as “Emergency lighting”. Set E1/E2 to 50 level in this scene. (Suppose 50 light level is sufficient to meet emergency lighting requirement, otherwise please set the scene to desired level) Set N1/N2 to 0 level in this scene.

When normal power is disrupted:

Set action to “Scene” and select “Emergency lighting”. Repeat every 5 seconds.

When normal power is restored:

Set action to “group” and set the “All lights” group to “Auto” light level.

Typical applications

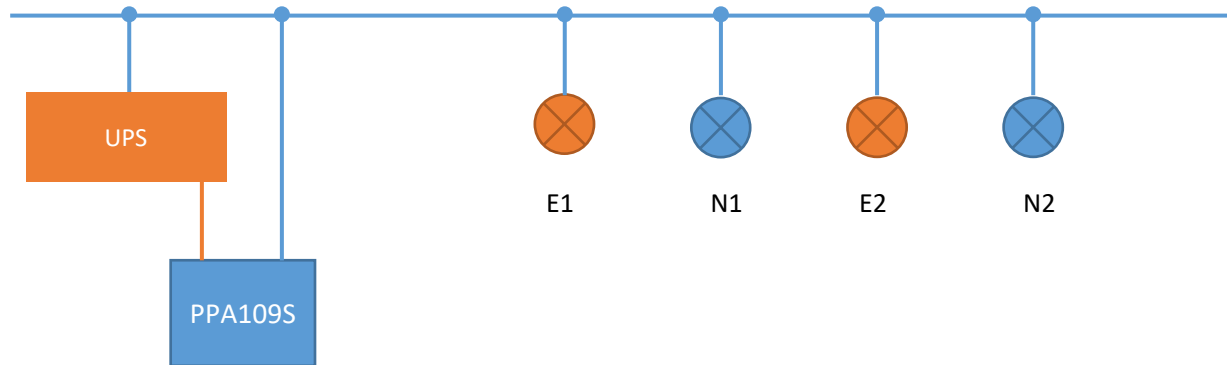

Legend:



Normal power supply



Emergency power supply



An UPS (Uninterruptible Power Supply) to provide power supply to PPA109S when normal power is disrupted.



Normal luminaires, provide lighting under normal conditions.



Emergency luminaires with internal chargeable battery Provide lighting under both normal and emergency conditions.

Typical application

There is only a normal power supply. All luminaires are controlled by Wave smart lighting controllers. Emergency luminaires are installed with emergency driver and provide lighting under both normal and emergency conditions. Other luminaires are powered by normal power supply and only provide lighting under normal conditions.

Emergency driver has internal chargeable battery and can provide high voltage power supply to luminaires when normal power is interrupted.

An UPS is used to provide emergency power supply to PPA109S.

Suggested configuration:

When normal power is disrupted:

Set action to “group” and set the “All lights” group to “50” light level. (Suppose 50 light level is sufficient to meet emergency lighting requirement, otherwise please set the scene to desired level) Repeat every 5 seconds.

When normal power is restored:

Set action to “group” and set the “All lights” group to “Auto” light level. Action.

Typical applications

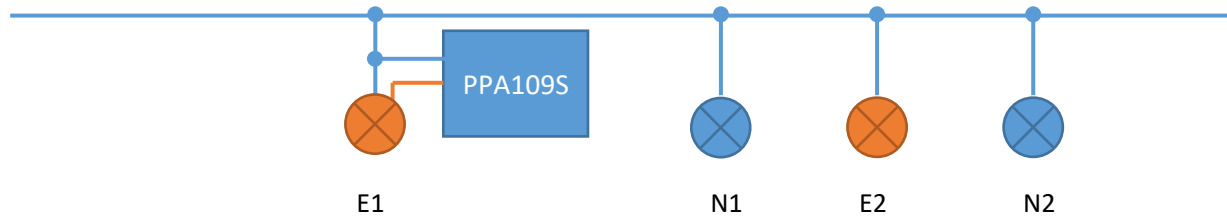

Legend:



Normal power supply



Emergency power supply



Normal luminaires, provide lighting under normal conditions.



Emergency luminaires with internal chargeable battery Provide lighting under both normal and emergency conditions.

Typical application

There is only a normal power supply. All luminaires are controlled by Wave smart lighting controllers. Emergency luminaires are installed with emergency driver and provide lighting under both normal and emergency conditions. Other luminaires are powered by normal power supply and only provide lighting under normal conditions. Emergency driver has internal chargeable battery and can provide high voltage power supply to luminaires and PPA109S(*) when normal power is interrupted.

Suggested configuration:

When normal power is disrupted:

Set action to “group” and set the “All lights” group to “50” light level. (Suppose 50 light level is sufficient to meet emergency lighting requirement, otherwise please set the scene to desired level)
Repeat every 5 seconds.

When normal power is restored:





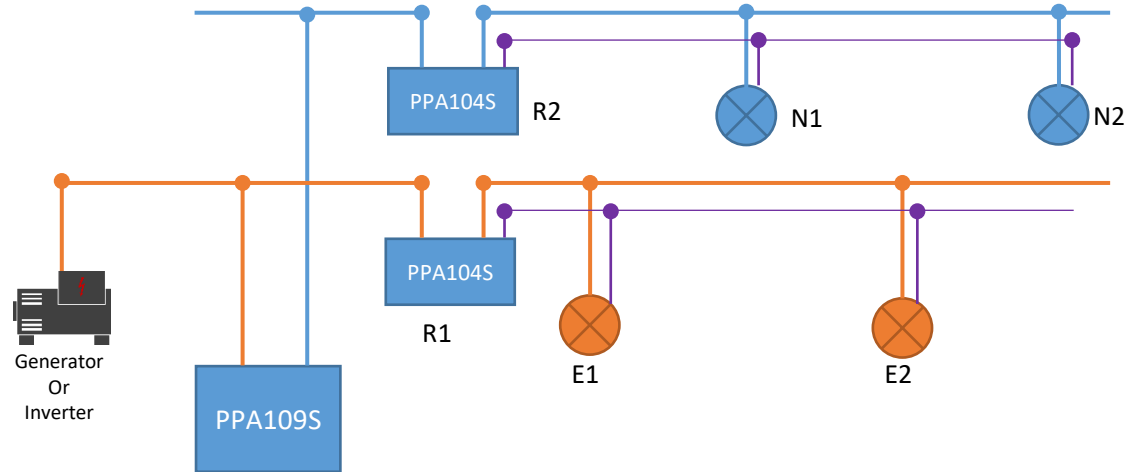

Set action to “group” and set the “All lights” group to “Auto” light level. Action.

**PPA109S accepts both AC 120-277v and DC 120-277v as emergency power supply.*

Typical applications



Legend:

-  Normal power supply
-  Emergency power supply
-  0-10v dimming line
-  Normal luminaires, provide lighting under normal conditions.
-  Emergency luminaires. Install at critical positions to provide lighting only under emergency conditions.
-  A generator or inverter to provide centralized emergency power supply

Typical application

Emergency and normal power supply are separate. All luminaires are ordinary (dimmable or non-dimmable) without Wave smart lighting controllers. Emergency luminaires are installed at critical positions and powered by emergency power supply. They only provide lighting under emergency conditions. Other luminaires are powered by normal power supply and only provide lighting under normal conditions.

Suggested configuration:

There are Wave Zone Controllers (PPA104S) to manage the normal power circuit, emergency power circuit and all luminaires. Create a group as “Emergency lights” and add R1 as the group members. Create a scene as “Normal lighting” and set R1 to TURN OFF and R1 TURN ON with 100 output level.

When normal power is disrupted:

Set the action to “group” and set the “Emergency lights” group to “50” light level. (Suppose 50 light level is sufficient to meet emergency lighting requirement, otherwise please set the scene to desired level) Repeat every 5 seconds.

When normal power is restored:

Set action to “Scene” and select “Normal lighting”.